

LH PART NO	RH PART NO	DIM A	DIM B	DIM C	THUMB BUTTON	NOSE
SDL-T28J	SDR-T28J	.283	.335	.410	DELUXE	SMALL
SDL-T25F	SDR-T25F	.248	.335	.121	FIN	SMALL
SDL-T28F	SDR-T28F	.283	.335	.121	FIN	SMALL

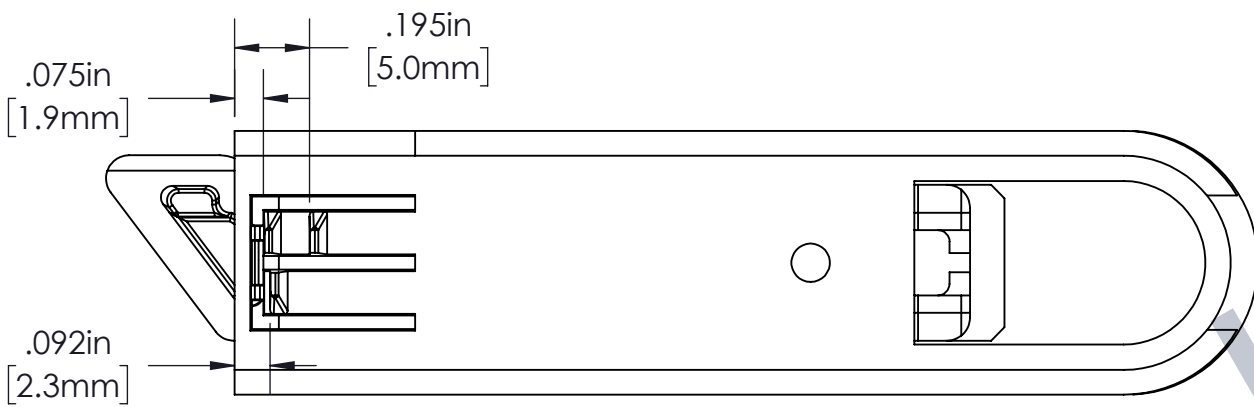

THUMB BUTTON VISUALS

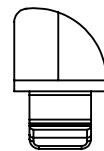
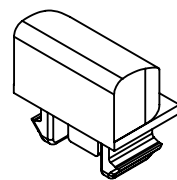

FIN - 11664

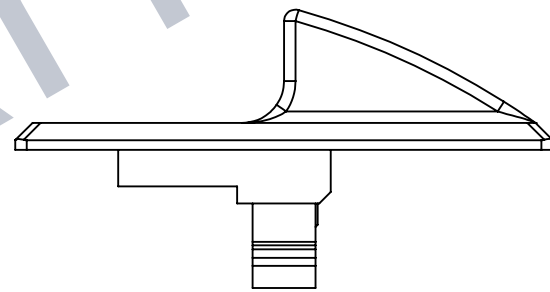
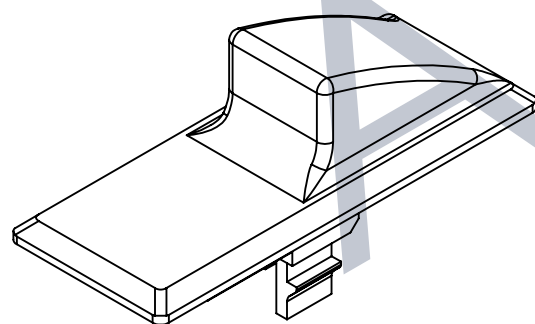

DELUXE - 11669

SMALL NOSE FABRICATION

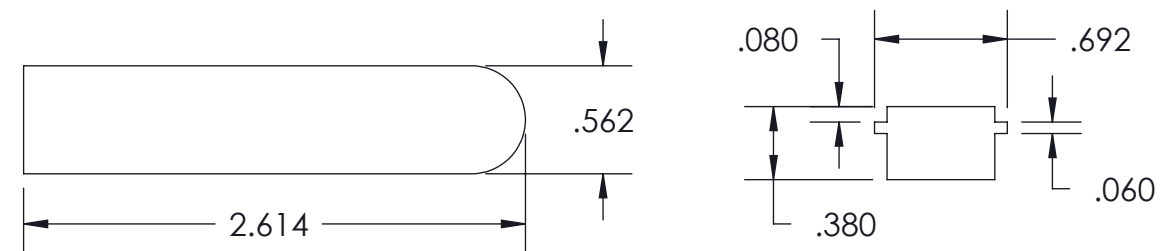

LARGE NOSE FABRICATION

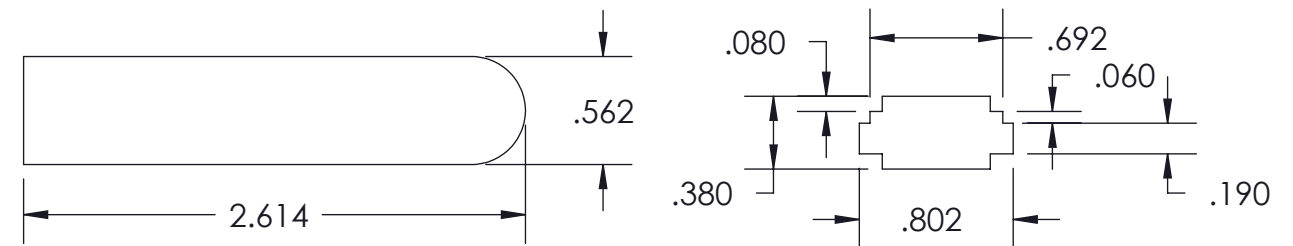

CUSTOMER PAGE

<p>Amesbury Truth Engineered Solutions. Trusted Results.</p>	INTERPRET PER: ASME Y14.5M-2009 UNITS: INCH	DRAWING TITLE: FLEX-FIT_RADIUS BODY_STRAIGHT NOSE
	THIRD ANGLE PROJECTION 	SCALE: 2:1 DRAWING #: SIGHTLINE TILT LATCH
<small>THE INFORMATION CONTAINED IN THIS DRAWING IS CONFIDENTIAL AND PROPRIETARY. THIS DRAWING IS NOT TO BE COPIED OR REPRODUCED IN WHOLE OR IN PART WITHOUT EXPRESS WRITTEN PERMISSION.</small>		