

REV	DESCRIPTION	DATE	ECO#	BY
-----	-------------	------	------	----

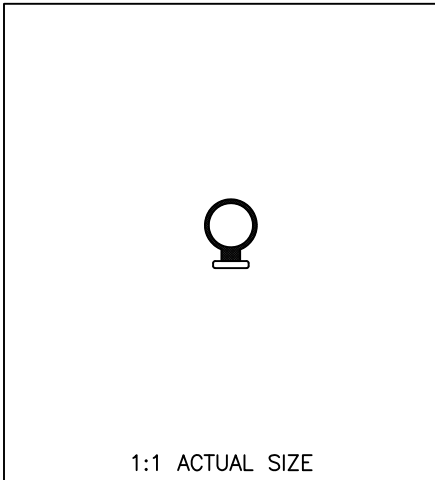

REFER TO CAD DRAWING FOR ALL DIMENSIONS NOT FULLY CONSTRAINED.

1:1 ACTUAL SIZE

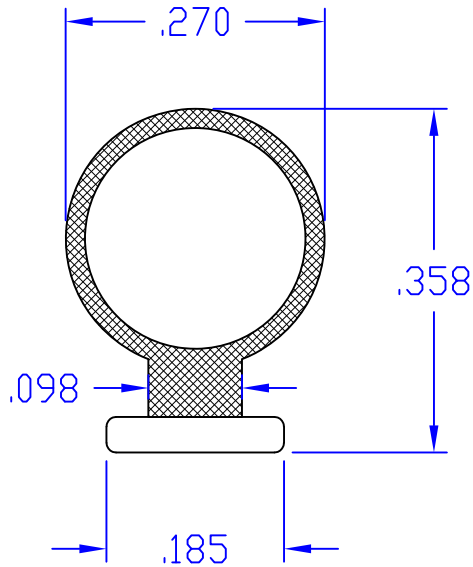

INTERPRET PER:
SAME Y14.5M-2009
UNITS: INCH
TOLERANCE UNLESS
OTHERWISE SPECIFIED

DRAWING TITLE:
- CUSTOMER PAGE -

T-SLOT BULB SEAL

DRAWN BY: **DCL** CHECKED BY:
SCALE: **5:1** SHEET: **1 OF 1**

THE INFORMATION CONTAINED IN THIS DRAWING IS CONFIDENTIAL AND PROPRIETARY. THIS DRAWING IS NOT TO BE COPIED OR REPRODUCED IN WHOLE OR IN PART WITHOUT EXPRESS WRITTEN CONSENT.

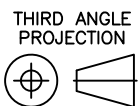

CAD TYPE: **AUTOCAD** SIZE: **A** DRAWING #: **PP0791** REV: **3**